

---

# BuzziTripl Desk

## Product Specification Sheet

---

This document contains technical information about the BuzziTripl Desk

---



[www.buzzi.space](http://www.buzzi.space)



## Simple and private desk partition







Safeguard your privacy with this simple desk divider made of three layers of felt.

Create your own cocoon with this flexible solution. You will definitely increase concentration while experiencing a nesting feeling. Being easy-to-install, you can use it individually or connect several together, by ordering the fix, to define multiple workstations. With its tactile appearance and colorful options, BuzziTripl Desk offers you the possibility to match it with your existing decor. You can also choose the shape that best meets your needs: round corners or wedge.

Design by BuzziSpace Studio

---

## General

-  BuzziTripl Desk
-  Outside layers: BuzziFelt 6 mm | 0.24" (both sides)  
Core: Furniture Felt 6 mm | 0.24"
-  Min. Width 50 cm | W 19.69"      Height 20 cm | W 7.87"  
Max. Width 200 cm | W 78.74"      Height 45 cm | W 17.72"  
Thickness: 1,45 cm | 0.57"
-  Dry use
-  Flat Packed  
Desk mounted
-  2 shapes: round corners or wedge

---

## Acoustics



---

## Certifications



---

## Content

Configurations	3
Shapes	4
BuzziTripl Desk Fix Overview	4
Fabrics	4
Dimensions	5
Acoustics	8

# Configurations

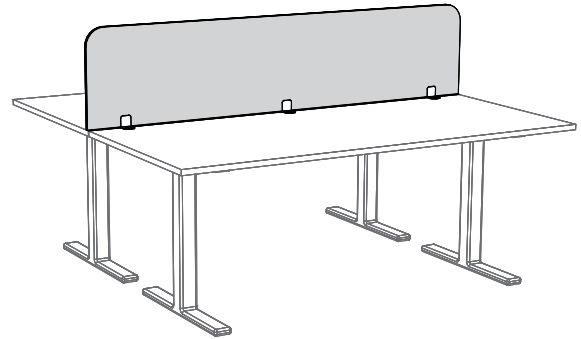
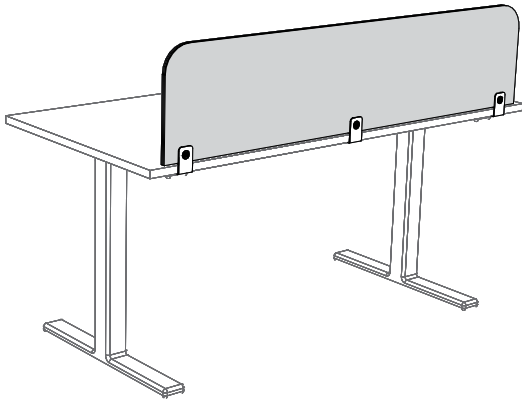

📍 BuzziTripl Desk

🌲 Outside layers: BuzziFelt 6mm | 0.24" (both sides)  
Core: Furniture Felt 6mm | 0.24"

✂ Min. Width 50 cm | W 19.69"      Height 20 cm | W 7.87"  
✂ Max. Width 200 cm | W 78.74"      Height 45 cm | W 17.72"  
Thickness: 1,45 cm | 0.57"

⚖ Weight panel: 3,75 kg/m<sup>2</sup> | 2.52 lbs/ft<sup>2</sup>

••• 2 shapes: round corners or wedge

# Shapes

## Round corners

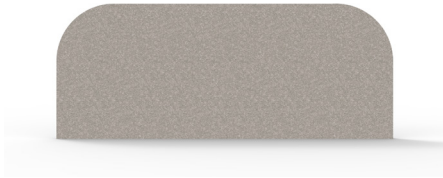

## Wedge

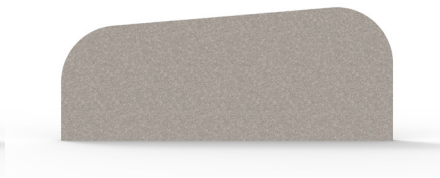

# BuzziTripl Desk Fix Overview

BuzziTripl Desk Fix is available in powder coated metal black (RAL 9005) or White (RAL 9010)

2 pcs/BuzziTripl Desk for width: 50 - 120 cm | 19.69" - 47.24"

3 pcs/BuzziTripl Desk for width: 121 - 180 cm | 47.64" - 70.87"

4 pcs/BuzziTripl Desk for width: 181 - 200 cm | 71.26" - 78.74"

## FIX Y included

### L

Worktop: 12 > 27 mm  
0.47" > 1.06"  
Including Screws

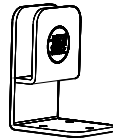

### L-Plus

Worktop: 18 > 43 mm  
0.71" > 1.69"  
Including Screws

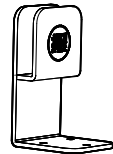

### XL

Worktop: 28 > 57 mm  
1.10" > 2.24"  
Including Screws

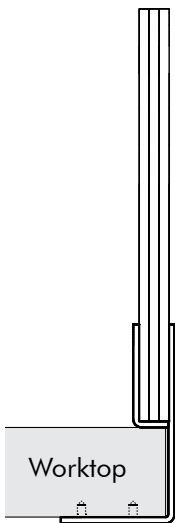
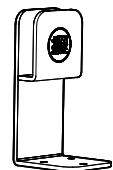

## Fix Foot included

Two antiskid pads underneath the fix

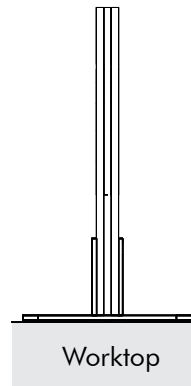
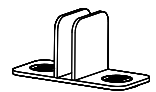

## Connection part X optional

Connects 4  
BuzziTripl Desk

Adds 17 mm | 0.67"  
to width

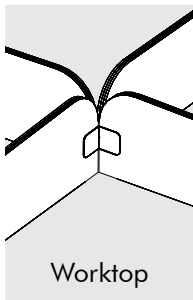
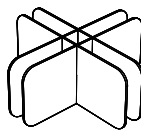

## Connection part H optional

Connects 2  
BuzziTripl Desk

Adds 1,5 mm | 0.06"  
to width

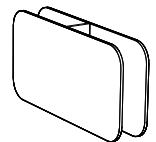
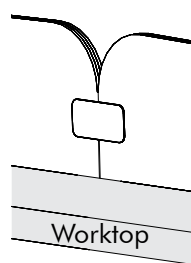

# Fabrics

---

## Felt

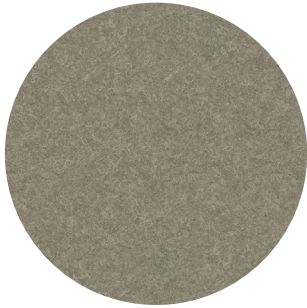

**Composition** 100% Recycled PE.T. Felt, latex backing

**Weight** 1.000 g/m2 | 29.49 oz/yd2

**Abrasion resistance** >7.000 Martindale

**Flammability** EU: EN 13501.1 + A1/2009 Class B-s1,d0  
USA: ASTM E84 Class A certified

**Fastness to light** USA 5



\*Not available in Ecobrown 58

# Dimensions

---

## Tripl Round Corners

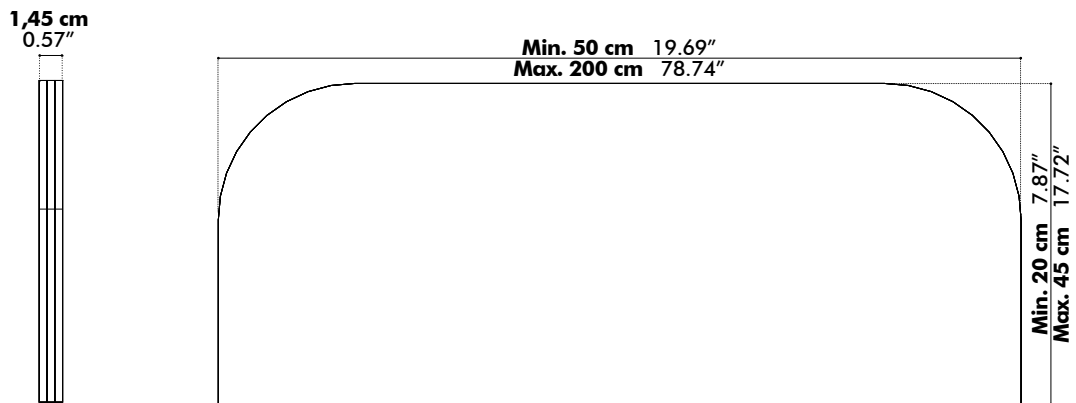

## Tripl Wedge

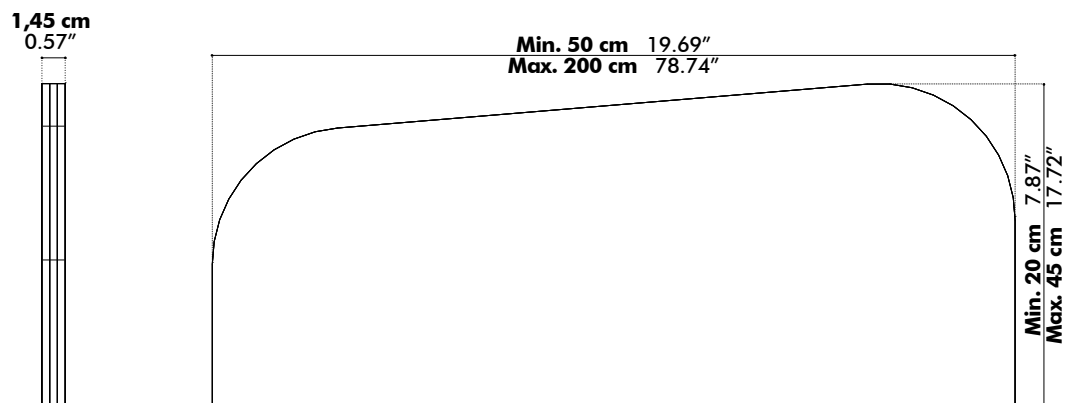

# BuzziTripl Desk Fix

Metal Thickness 0,3 cm | 0.12"

## Y L

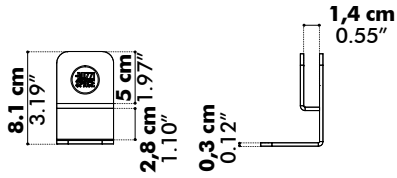
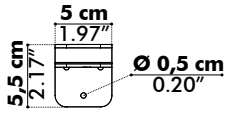

223 g/pc | 0.49 lbs/pc

## Y L-Plus

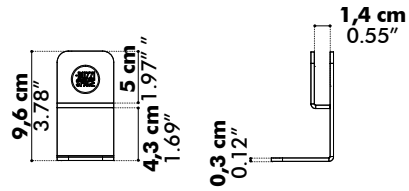
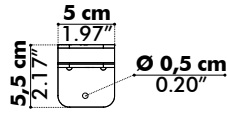

239 g/pc | 0.53 lbs/pc

## Y XL

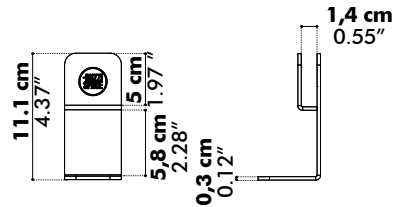
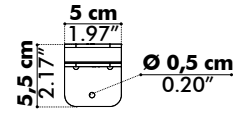

257 g/pc | 0.57 lbs/pc

## Foot

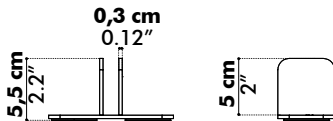
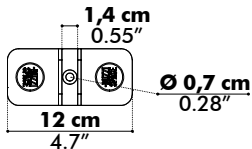

244 g/pc | 0.54 lbs/pc

## X

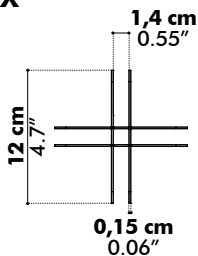

266 g/pc | 0.59 lbs

## H

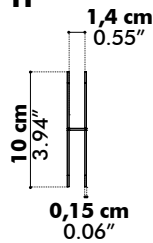

125 g/pc | 0.28 lbs

# Acoustics

## BuzziTripl Desk

Equivalent sound absorption area in m<sup>2</sup> per object

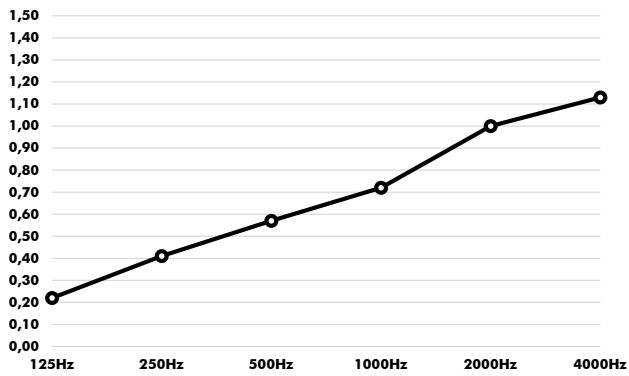

Hz	Aeq/m <sup>2</sup>
125	0,22
250	0,41
500	0,57
1000	0,72
2000	1
4000	1,13